



WAVE LINE 2023

WWW.BLUEWAVE.DK

BLUE WAVE[®]
HEIGHT SAFETY FITTINGS

CONTENTS

5

INFORMATION

7

MACHINE SWAGE FITTINGS

- 7 Tension fork turnbuckles
- 8 Rigging screws
- 10 Terminals

10

HAND CRIMP FITTINGS

- 12 Tension fork turnbuckles
- 13 Rigging screws
- 14 Terminals

14

SWAGELESS FITTINGS

- 16 Tension fork turnbuckles
- 17 Rigging screws
- 18 Terminals
- 19 Swageless instruction



20

SPARE PARTS

- 20 Rigging screws
- 21 Long thread terminals
- 22 Thread terminals
- 23 Bodies
- 23 Tension fork
- 24 Accessories

24

WIRE ROPE

25

MACHINES AND TOOLS



GENERAL INFORMATION

Ensuring the safety of individuals working at height with correct wire attachment is crucial. This catalogue contains the components for our height safety wire system.

WIRE ATTACHMENT

The Blue Wave height safety fittings can be divided into three groups of wire terminals; each with an individual way of wire attachment.

- **Machine swage fittings**

To reach optimal break load we recommend pressing or swaging/rolling the terminals onto the wire ropes.

Recommended machines are e.g. presses from TALURIT and roller swaging machines from WIRETEKNIK.



PRESS



SWAGE

- **Hand crimp fittings**

A range of fittings with an outside diameter of Ø 13 mm that can be crimped onto the wires by using a handtool.

Recommended tool is e.g. the Dubuis 18V Li-ion batterydriven tool.



CRIMP

- **Swageless fittings**

Swageless terminals enables onsite attachment when machines are not available or if the exact length of the wire is unknown.



SCREW



Please pay attention to the icons in this catalogue

BREAK LOAD

Proper termination onto the wire can only be achieved by firmly pressing the material of the terminal onto the strands of the wire. In this way approximately 90 % of the wire break load will be achieved. When working with jaw terminals the gap must be filled to minimum 80 % of the jaw width in order to reach optimal break load. Swage tabs can be seen on www.bluewave.dk under "Catalogues and technical guidelines".

TRACEABILITY

Blue Wave products can be marked with a serial number if requested. This makes it possible for products to be traced back to specific production batches and raw material.

Declaration of compliance with order, test reports and inspection certificates are also made to order on request.





Tension turnbuckles for permanent and engineered height safety lifelines

Developed in accordance with DIN EN795, the new range of turnbuckles offer easy installation and inspection on Ø 8 mm (5/16") lifelines in almost every environment and application.

They are available as tension device and load indicator only and as tensioner, load indicator and compression shock absorbing device in one.

Users can easily adjust and read tension indicated on the turnbuckle where the innovative and compact design allows for short distance to anchor points. Sign of load impact will be clearly visual at inspection.



NEW RANGE OF TURNBUCKLES



THE TURNBUCKLE SYSTEM FEATURES:

- 100 % traceability in production
- Easy installation - one side, 115 mm/4,5" adjustment
- Innovative and compact design with accurate and easy to use 800N load indicator
- Pin secured with lock nut, thread engagement inspection and seal holes
- AISI 316L stainless steel and alubronze materials
- Thread is visible through inspection hole when the turnbuckle is mounted correctly and loaded to 80 kg
- Design registered in Europe, the United Kingdom and Australia

AVAILABLE WITH:

- Ø 8 mm and 5/16" machine swage -, hand crimp - and swageless wire terminals
- Built in shock absorber, releasing at 600 kg/1.322 lbs; compresses up to 1.900 kg/4.188 lbs
- Loose spare terminals

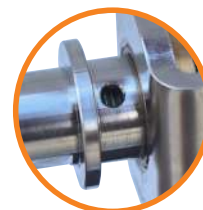

MACHINE SWAGE FITTINGS

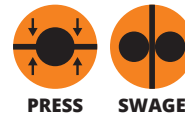

We recommend pressing or swaging/rolling the terminals onto the wire ropes in order to achieve optimal break load.

TENSION FORK TURNBUCKLE WITH LOAD INDICATOR

Stainless steel - AISI 316L and alubronze

ART. NO.	WIRE	G	PIN	A	B	D1	D2	L1	L2	KW	BL/KG	KG/100	PACK
TF800812A	8	1/2"	12	17	42	16	3	386	276	16	6100	82,8	10

Spare terminals see page 21

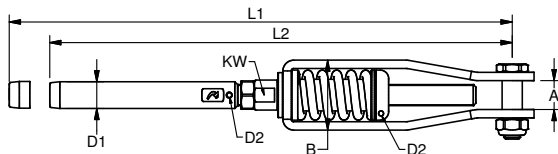

TENSION FORK TURNBUCKLE WITH LOAD INDICATOR AND BUILD-IN SHOCK ABSORBER

Stainless steel - AISI 316L and alubronze

ART. NO.	WIRE	G	PIN	A	B	D1	D2	L1	L2	KW	BL/KG	KG/100	PACK
SA800812A	8	1/2"	12	17	42	16	3	435	325	16	6100	101,4	10

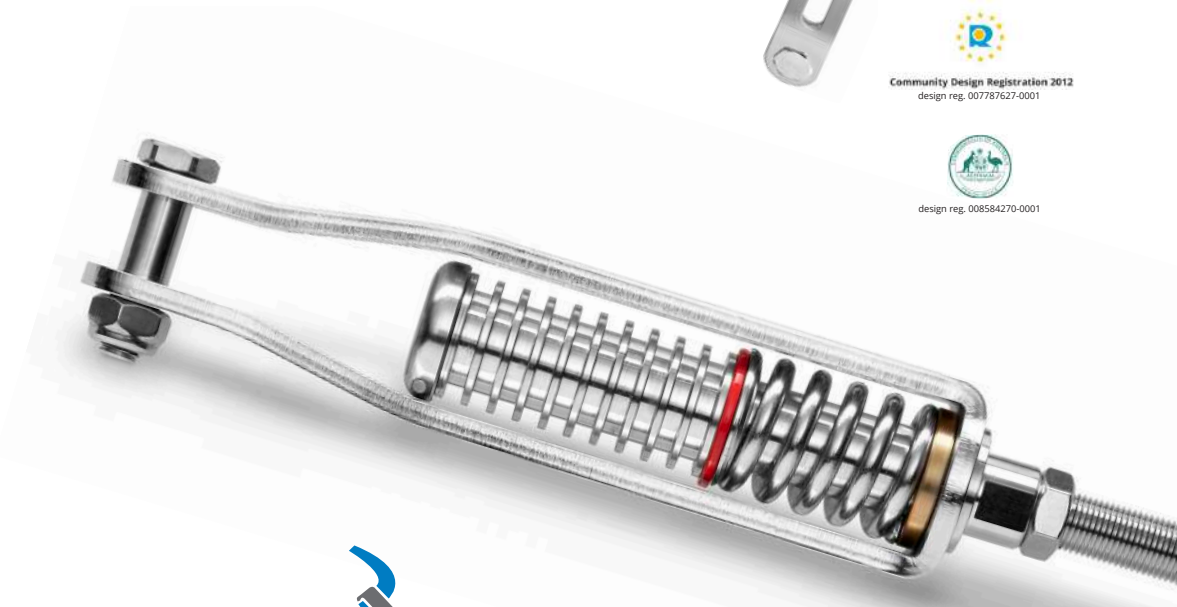
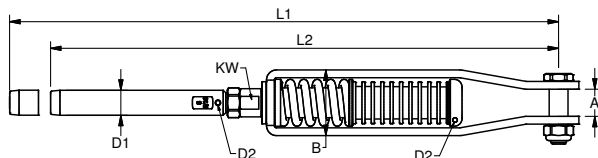

RIGGING SCREW TENSION FORK/TERMINAL

Polished stainless steel - AISI 316

ART. NO.	G	WIRE	PIN	A	B	D	L1	L2	BL/KG	PACK
130812ATBW	1/2"	8	12	17	43	16	472	378	6100	10

Spares/loose parts see pages 22 and 23

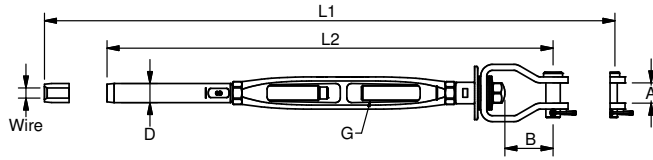

**Calibrated to 800N
Handle with care**

RIGGING SCREW TENSION FORK/TERMINAL

Polished stainless steel - AISI 316

ART. NO.	G	WIRE	PIN	A	B	D	L1	L2	BL/KG	PACK
120812ATBW	1/2"	8	12	17	43	16	456	364	6100	10

Spares/loose parts see pages 22 and 23

**Calibrated to 800N
Handle with care**



RIGGING SCREW FORK/TERMINAL

Polished stainless steel - AISI 316L

ART. NO.	G	WIRE	PIN	A	B	D	L1	L2	BL/KG	PACK
120812A	1/2"	8	12,7	14	25	16	416	310	6100	5
120812	M12	8	12	14	25	16	416	310	5100	5
120814	M14	8	12	14	25	16	453	333	6800	5
120816AX	5/8"	8	16	18	32	16	499	366	8000	5
120816X	M16	8	16	18	32	16	499	366	8000	5

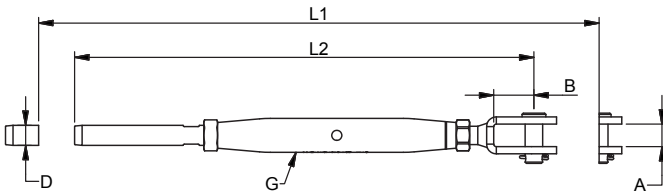

RIGGING SCREW FORK/TERMINAL

Polished stainless steel - AISI 316L and chromed bronze body

ART. NO.	G	WIRE	PIN	A	B	D	L1	L2	BL/KG	PACK
130812AN	1/2"	8	12,7	14	25	16	422	332	6100	5
130816AXN	5/8"	8	16	17	33	16	498	390	8000	5



RIGGING SCREW TOGGLE/TERMINAL

Polished stainless steel - AISI 316L

ART. NO.	G	WIRE	PIN	A	B	D	L1	L2	BL/KG	PACK
320812AX	1/2"	8	12,7	18	35	16	444	338	6100	5
320812X	M12	8	12,7	18	35	16	440	350	5100	5
320814X	M14	8	12,7	18	35	16	497	383	6900	5
320816AX	5/8"	8	16	20	41	16	533	419	8000	-
320816X	M16	8	16	20	41	16	528	398	8000	-

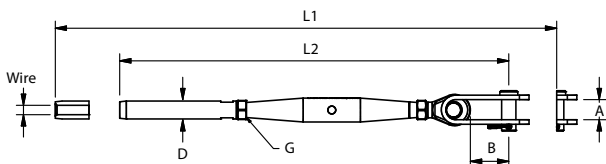

RIGGING SCREW TOGGLE/TERMINAL

Polished stainless steel - AISI 316L and chromed bronze body

ART. NO.	G	WIRE	PIN	A	B	D	L1	L2	BL/KG	PACK
330812AXN	1/2"	8	12,7	18	35	16	459	367	6100	5
330816AXN	5/8"	8	16	20	40	16	549	439	8000	-





TOGGLE TERMINAL

Polished stainless steel - AISI 316L

ART. NO.	WIRE	PIN	A	B	D	L1	L2	L3	BL/KG	PACK
501308	8	12,7	18	33	16	170	83	30	6500	5
501608X	8	16	20	38,8	16	198,8	83	35	8700	5

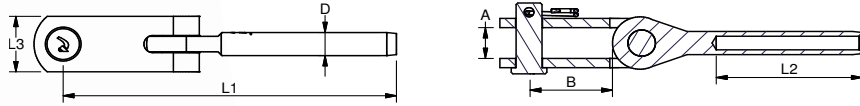

THREAD TERMINAL

Polished stainless steel - AISI 316L

ART. NO. RIGHT	ART. NO. LEFT	G	WIRE	D1	L1	L2	L3	BL/KG
930812A	940812A	1/2"	8	16	185	80	83	6100
900812	910812	M12	8	16	185	80	83	5100
900814	910814	M14	8	16	194	83	89	6900
930816A	940816A	5/8"	8	16	203	83	100	8700
900816	910816	M16	8	16	203	83	100	8700

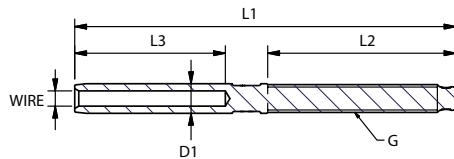

FORK TERMINAL

Polished stainless steel - AISI 316L

ART. NO.	WIRE	PIN	A	B	D	L1	L2	BL/KG	PACK
101208	8	12	14	25	16	136	83	6500	10
101408	8	14	18	33	16	143	83	8000	10
101608	8	16	18	33	16	145	83	8500	10

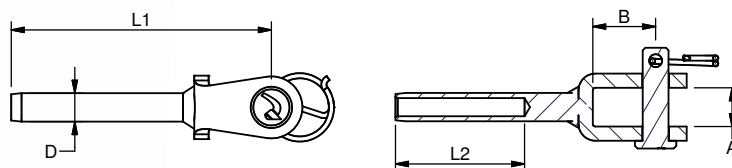

EYE TERMINAL

Polished stainless steel - AISI 316L

ART. NO.	WIRE	T	B	D1	D2	L1	L2	BL/KG	PACK
190008	8	10	30	16	14,5	124	83	8000	10
190008X	8	12	36	16	16,5	141	83	8700	10

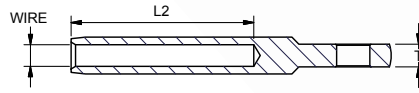
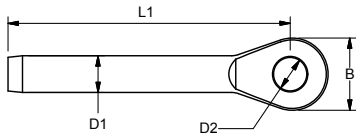

HAND CRIMP FITTINGS



This range of fittings has an outside diameter of \varnothing 13 mm and can be crimped onto wire ropes by use of a hand tool.



HAND CRIMP TENSION FORK TURNBUCKLE WITH LOAD INDICATOR

Stainless steel - AISI 316L and alubronze

ART. NO.	WIRE	G	PIN	A	B	D1	D2	L1	L2	KW	BL/KG	KG/100	PACK
TF800812AD	8	1/2"	12	17	42	13	3	386	276	16	4600	76,8	10

Spare terminals see page 21

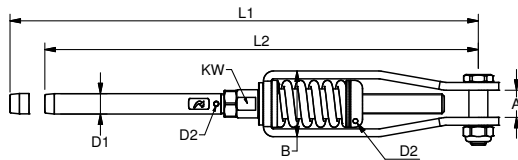

HAND CRIMP TENSION FORK TURNBUCKLE WITH LOAD INDICATOR AND BUILT-IN SHOCK ABSORBER

Stainless steel - AISI 316L and alubronze

ART. NO.	WIRE	G	PIN	A	B	D1	D2	L1	L2	KW	BL/KG	KG/100	PACK
SA800812AD	8	1/2"	12	17	42	13	3	435	325	16	4600	95,5	10

Spare terminals see page 21

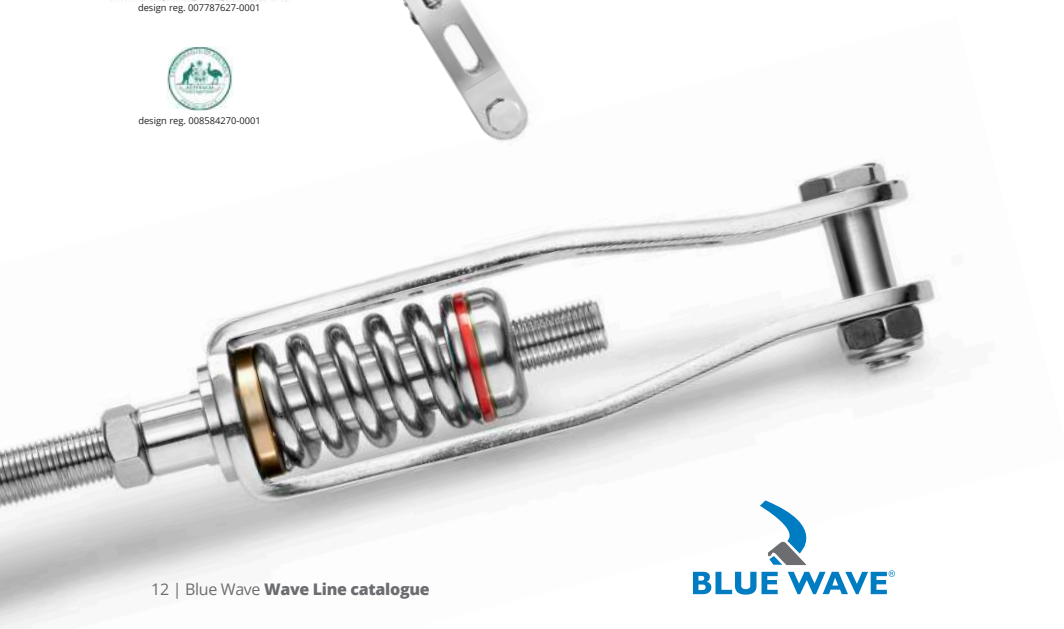
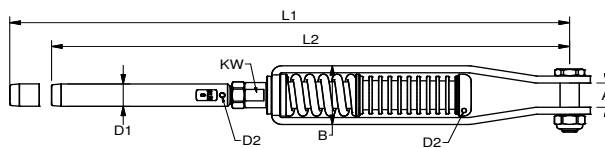

RIGGING SCREW FORK/TERMINAL

Polished stainless steel - AISI 316L

ART. NO.	G	WIRE	PIN	A	B	D	L1	L2	BL/KG	PACK
126812A	1/2"	8	12,7	14	25	13	404	316	4600	10
126812	M12	8	12	14	25	13	416	316	4600	10

Note:  Also available with open body on request

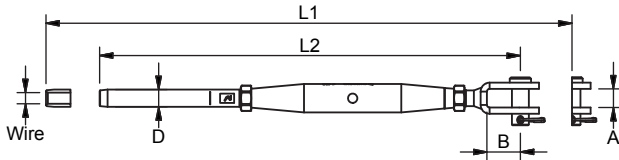

RIGGING SCREW TOGGLE/TERMINAL

Polished stainless steel - AISI 316L

ART. NO.	G	WIRE	PIN	A	B	D	L1	L2	BL/KG	PACK
320812AD	1/2"	8	12,7	18	35	13	442	348	4600	10
32081213	M12	8	12	18	35	13	458	348	4600	10

Note:  Also available with open body on request

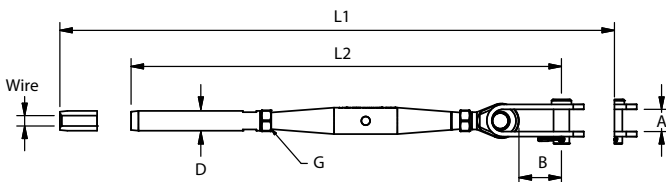

RIGGING SCREW TENSION FORK/TERMINAL

Polished stainless steel - AISI 316L

ART. NO.	G	WIRE	PIN	A	B	D	L1	L2	BL/KG	PACK
SS1308ATBW	1/2"	8	12	17	43	13	472	378	4600	10

Note:  Also available with closed body on request

Spares/loose parts see pages 22 and 23

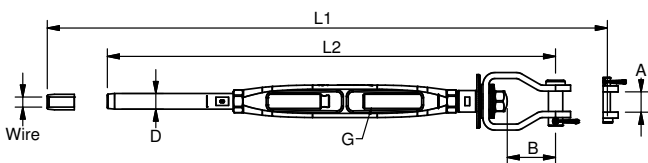

Calibrated to 800N
Handle with care





TOGGLE TERMINAL

Polished stainless steel - AISI 316L

ART. NO.	WIRE	PIN	A	B	D	L1	L2	L3	BL/KG	PACK
501208D	8	12,7	18	34	13	173	83	30	4600	5

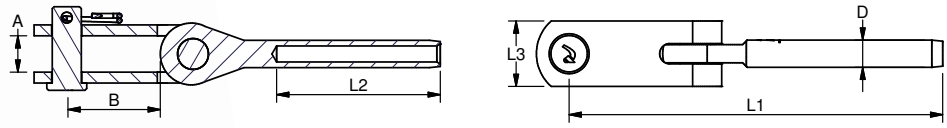

THREAD TERMINAL

Polished stainless steel - AISI 316L

ART. NO. RIGHT	ART. NO. LEFT	G	WIRE	D1	L1	L2	L3	BL/KG
930812D	940812D	1/2"	8	13	185	80	83	4600
90081213	91081213	M12	8	13	185	80	83	4600

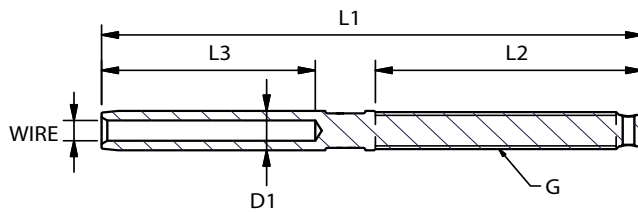

FORK TERMINAL

Polished stainless steel - AISI 316L

ART. NO.	WIRE	PIN	A	B	D	L1	L2	BL/KG	PACK
101208D	8	12	14	25	13	136	83	4600	10

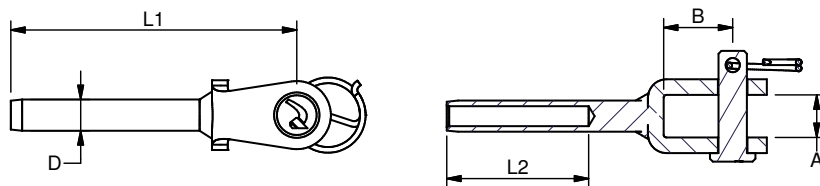

DOUBLE TERMINAL

Polished stainless steel - AISI 316L

ART. NO.	WIRE	D	L1	L2	BL/KG	PACK
90080813G	8	13	190	80	4600	10

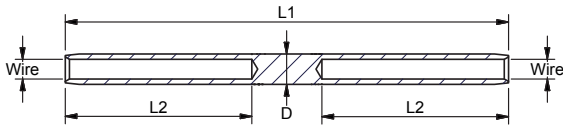

EYE TERMINAL

Polished stainless steel - AISI 316L

ART. NO.	WIRE	T	B	D1	D2	L1	L2	BL/KG	PACK
190008D	8	10	30	13	14,5	123,5	83	4600	10

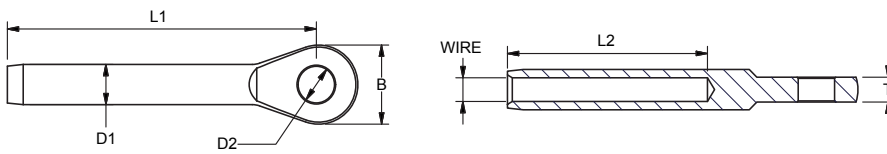

SWAGELESS FITTINGS

Swageless terminals enables onsite attachment when machines are unavailable or if the exact length of the final wire is unknown.



design reg. 008584270-0001

SWAGELESS TENSION FORK TURNBUCKLE WITH LOAD INDICATOR

Stainless steel - AISI 316L and alubronze

ART. NO.	WIRE	G	PIN	A	B	D	L1	L2	KW	BL/KG	KG/100	PACK
TF8008SS	8	1/2"	12	17	42	3	246	356	16	5600	89,3	10

Spare terminals see page 21

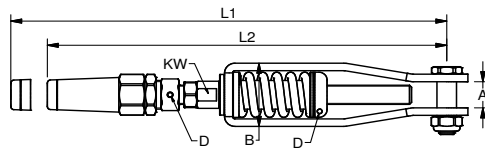

design reg. 008584270-0001

SWAGELESS TENSION FORK TURNBUCKLE WITH LOAD INDICATOR AND BUILT-IN SHOCK ABSORBER

Stainless steel - AISI 316L and alubronze

ART. NO.	WIRE	G	PIN	A	B	D2	L1	L2	KW 1	KW 2	BL/KG	KG/100	PACK
SA8008SS	8	1/2"	12	17	42	3	405	295	24	16	5600	108	10

Spare terminals see page 21

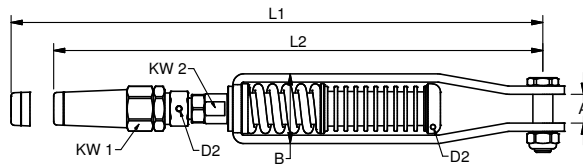

RIGGING SCREW SWAGELESS FORK/TERMINAL

Polished stainless steel - AISI 316L - suits 7x7 and 7x19 wire construction

ART. NO.	G	WIRE	PIN	A	B	KW1	KW2	L1	L2	BL/KG	PACK
SS128012A	1/2"	8	12,7	14	25	19	24	379	291	5600	10
SS120812	M12	8	12	14	25	19	24	396	296	5600	10

Note:  Also available with open body on request

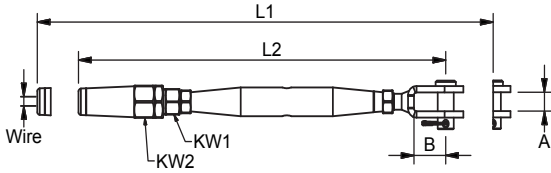

RIGGING SCREW SWAGELESS TOGGLE/TERMINAL

Polished stainless steel - AISI 316L - suits 7x7 and 7x19 wire construction

ART. NO.	G	WIRE	PIN	A	B	KW1	KW2	L1	L2	BL/KG	PACK
SS870812A	1/2"	8	12,7	18	35	19	24	404	326	5600	10

Note:  Also available with open body on request

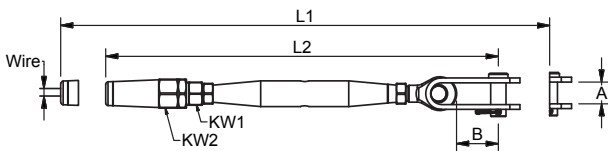

RIGGING SCREW SWAGELESS TENSION FORK/TERMINAL

Polished stainless steel - AISI 316L - suits 7x7 and 7x19 wire construction

ART. NO.	G	WIRE	PIN	A	B	KW1	KW2	L1	L2	BL/KG	PACK
SS8608ATBW	1/2"	8	12	17	43	19	24	355	447	5600	10

Note:  Also available with closed body on request

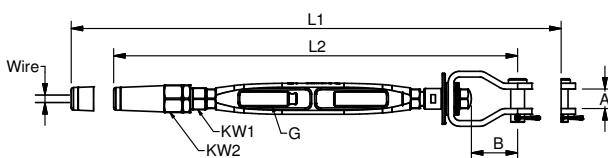

**Calibrated to 800N
Handle with care**



SWAGELESS TOGGLE TERMINAL

Polished stainless steel - AISI 316L - suits 7x7 and 7x19 wire construction

ART. NO.	WIRE	PIN	A	B	KW1	KW2	L1	L2	L3	BL/KG	PACK
831208SS	8	12,7	18	30	24	19	148	102	30	5600	5

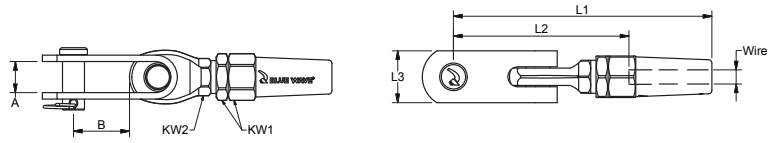

SWAGELESS THREAD TERMINAL

Polished stainless steel - AISI 316L - suits 7x7 and 7x19 wire construction

ART. NO. RIGHT	ART. NO. LEFT	G	WIRE	KW1	KW2	L1	L2	L3	BL/KG
800812ASS	810812ASS	1/2"	8	19	24	162	107	80	5600
800812SS	810812SS	M12	8	19	24	162	107	80	5100
800814SS	810814SS	M14	8	19	24	171	122	89	5600
800816ASS	810816ASS	5/8"	8	19	24	182	133	100	5600
800816SS	810816SS	M16	8	24	27	190	139	100	5600

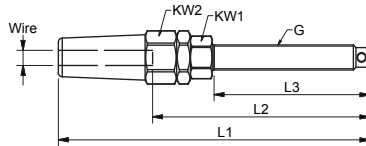

SWAGELESS FORK TERMINAL

Polished stainless steel - AISI 316L - suits 7x7 and 7x19 wire construction

ART. NO.	WIRE	PIN	A	B	KW1	KW2	L1	L2	L3	BL/KG	PACK
841208SS	8	12	14	21	24	58	103	118	58	5600	5
841408SS	8	14	14	21	24	58	103	118	58	5600	5

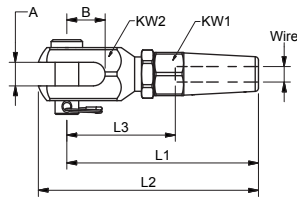

SWAGELESS EYE TERMINAL

Polished stainless steel - AISI 316L - suits 7x7 and 7x19 wire construction

ART. NO.	WIRE	T	KW1	KW2	D	L1	L2	L3	BL/KG	PACK
821908SS	8	10	19	24	14,5	121	103	52,5	5600	5

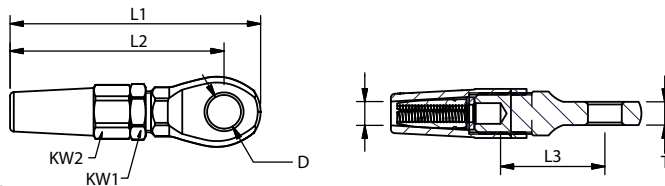

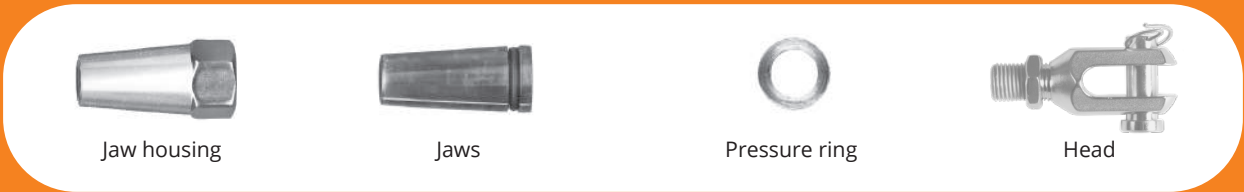

SWAGELESS INSTRUCTION



1  Slide the jaw housing in place on the cable.

4  Slide the jaw housing over the jaws.

2  Slide the jaws onto the cable, thereby ensuring that there is equal space between the jaws.

5  The terminal can now be assembled. Screw the head on the jaw housing with a torque wrench - min. 58 Nm (43 Lbf ft). Tighten the lock nut with min. 50 Nm (36 Lbf ft).

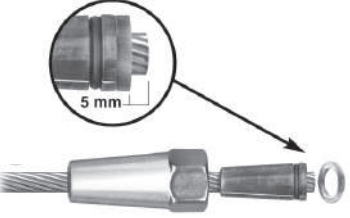
3  Place the brass pressure ring on the end of the cable. Make sure that the distance from the pressure ring to the end of the cable is 5 mm.

6 Do not reuse the jaws. Make sure that the dimensions of the terminal and cable match.

After the first dynamic load the terminal must be tightened again. The terminal is developed for use with 7x19 and 7x7 cables.

When assembling swageless terminals the breaking strength of the cable used will be reduced by 0-15 %. Refer to the table for the breaking strength of the terminal.

Swageless terminal breaking strength:

Wire dim.		Breaking strength	
8 mm	5/16"	54,5 KN	12,300 lbs

Tightening torque for swageless terminals:

Wire dim.	Nm	Lbf ft	
8 mm	5/16"	58	43

! On request also available with jaws for 1x19 wire construction

SPARE PARTS



RIGGING SCREW FORK/FORK

Polished stainless steel - AISI 316L

ART. NO.	G	PIN	A	B	L1	L2	BL/KG	PACK
120012A	1/2"	12,7	14	25	350	244	6100	5
120012	M12	12	14	25	350	244	5100	5
120014X	M14	14	18	32	405	295	6900	5
120016X	M16	16	18	33	446	313	9400	5

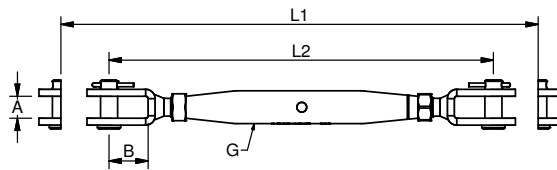

RIGGING SCREW TENSION FORK/FORK

Polished stainless steel - AISI 316L

ART. NO.	G	PIN1	PIN2	A1	A2	B1	B2	L1	L2	BL/KG	PACK
SS1300ATBW	1/2"	12	12,7	17	14	43	25	406	318	6100	10

Note:  Also available with closed body on request

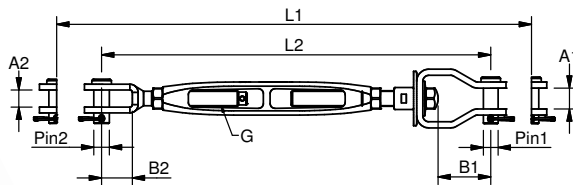

**Calibrated to 800N
Handle with care**



RIGGING SCREW LH FORK/BLANK

Polished stainless steel - AISI 316L

ART. NO.	G	PIN	A	B	L1	L2	BL/KG	PACK
120012S	M12	12	14	25	252	202	5100	5
120012AS	1/2"	12,7	14	25	246	202	6100	5

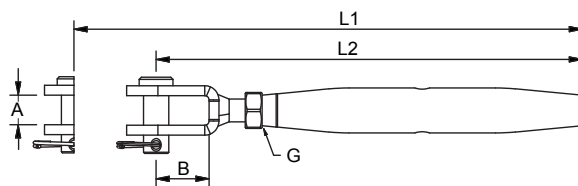

LONG THREAD TERMINAL

Stainless steel - AISI 316L



ART. NO.	WIRE	G	D1	D2	L1	L2	L3	BL/KG	KG/100	PACK
05M0812ATD	8	1/2"	13	3	254	142	84	4600	22	10

Spare terminal for art. no. TF800812AD and SA800812AD

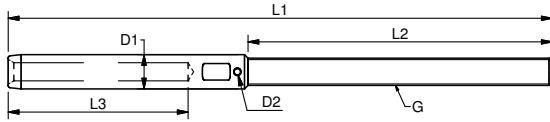

LONG THREAD TERMINAL

Stainless steel - AISI 316L



ART. NO.	WIRE	G	D1	D2	L1	L2	L3	BL/KG	KG/100	PACK
05M0812AT	8	1/2"	16	3	254	142	84	6100	28	10

Spare terminal for art. no. TF800812A and SA800812A



SWAGELESS LONG THREAD TERMINAL

Stainless steel - AISI 316L



ART. NO.	WIRE	G	D	L1	L2	KW1	KW2	BL/KG	KG/100	PACK
T800812ASS	8	1/2"	3	224	142	19	24	5600	35	10

Spare terminal for art. no. TF8008SS and SA8008SS

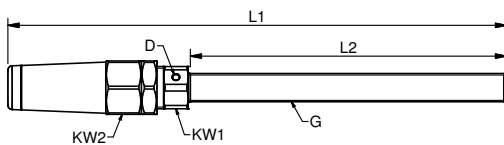



THREAD TOGGLE

Polished stainless steel - AISI 316L

ART. NO. RIGHT	ART. NO. LEFT	G	PIN	A	B	L1	L2	L3	BL/KG
023212AXB	033212AXB	1/2"	12,7	18	35	155	80	30	6100
023212XB	033212XB	M12	12,7	18	34	155	80	30	5100
023214B	033214B	M14	12,7	18	33	172	90	30	6900
023216AXB	033216AXB	5/8"	16	20	41	199	100	35	9900
023216XB	033216XB	M16	16	20	41	199	100	35	9400

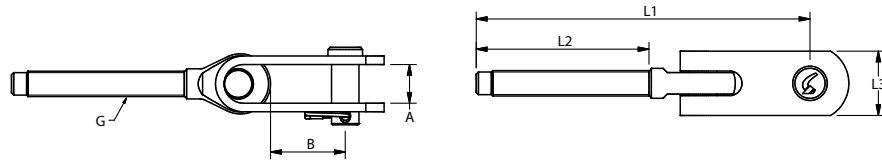

THREAD FORK

Polished stainless steel - AISI 316L

ART. NO. RIGHT	ART. NO. LEFT	G	PIN	A	B	L1	L2	BL/KG
021212AB	031212AB	1/2"	12,7	14	25	119	80	6100
021212B	031212B	M12	12	14	25	119	80	5000
021212XB	031212XB	M12	12	18	33	129	80	5000
021214B	031214B	M14	12	18	25	137	90	6900
021216AB	031216AB	5/8"	16	20	41	199	100	9900
021216B	031216B	M16	14	18	33	151	100	9400

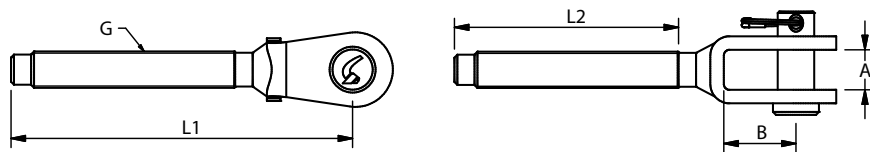

THREAD EYE

Polished stainless steel - AISI 316L

ART. NO. RIGHT	ART. NO. LEFT	G	T	D1	D2	L1	L2	BL/KG	PACK
021912A	031912A	1/2"	10	13,2	28	105	80	6100	10
021912	031912	M12	8	13	25	110	80	5100	10
021914	031914	M14	9	13	28	124	90	6800	10
021916A	031916A	5/8"	10	14,5	31	134	100	9900	10
021916	031916	M16	10	14,5	31	133	100	9400	10

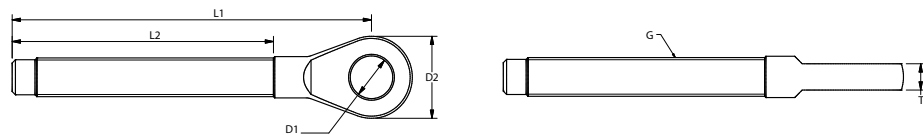

THREAD TERMINAL

Polished stainless steel - AISI 316L

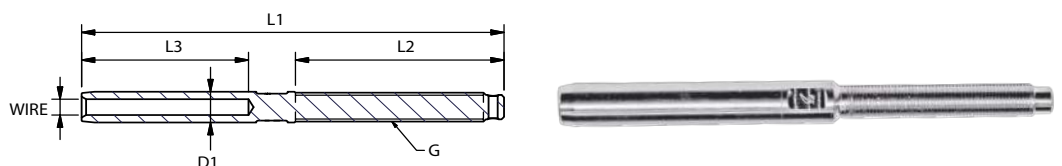

Note: For details please see data tables on pages 10 and 14

OPEN BODY

Stainless steel - AISI 316 and chromed bronze

ART. NO.	G	D	L	KW	MATERIAL	BL/KG	PACK
SS011312A	1/2"	27	170	17,4	Stainless steel	6100	1
SS011312	M12	27	170	17,4	Stainless steel	5100	1
011312A	1/2"	27	170	17,4	Bronze	6100	1
011312	M12	27	170	17,4	Bronze	5100	1
011316A	5/8"	32	210	20,7	Bronze	9900	1

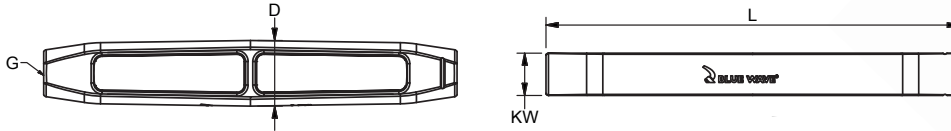

CLOSED BODY

Polished stainless steel - AISI 316L

ART. NO.	G	D	Ø	L	BL/KG	PACK
011212	M12	21	7	152	5100	1
011212A	1/2"	21	7	152	6100	1
011216	M16	27	8	190	9400	1
011216A	5/8"	27	8	190	9900	1

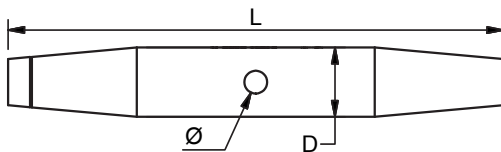

TENSION FORK

Polished stainless steel - AISI 316L

ART. NO.	G	A	B	L1	L2	BL/KG	PACK
0312ATFBW	1/2"	17	43	163	84	6100	10

Replacement fork for art. no. SS1308ATBW

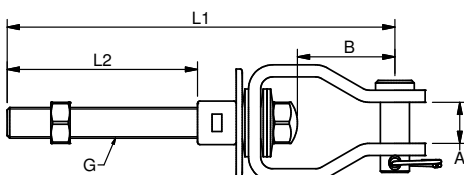

Calibrated to 800N
Handle with care



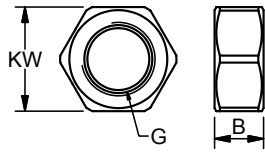

LOCK NUT

Polished stainless steel - AISI 316L

ART. NO. RIGHT	ART. NO. LEFT	G	KW	B
041212A	051212A	1/2"	17	8
041212	051212	M12	17	8
041214	051214	M14	19	10
041216A	051216A	5/8"	22	11
041216	051216	M16	22	11

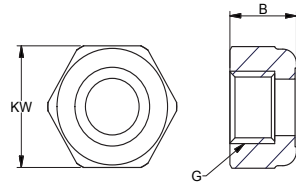

SECURITY NUT FOR TENSION FORK

Polished stainless steel - AISI 316L

ART. NO.	G	B	KW
044310S	M10	9,8	17

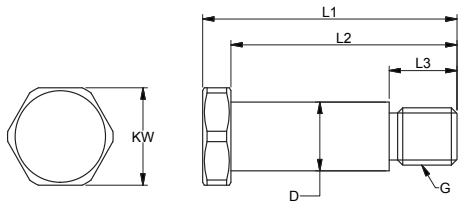

PIN FOR TENSION FORK

Polished stainless steel - AISI 316L

ART. NO.	G	D	KW	L1	L2	L3	BL/KG
062812TF	M10	12	17	45	40	12	2200

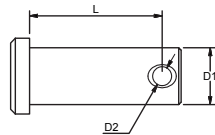

PIN

Polished stainless steel - AISI 316L

ART. NO.	D1	D2	L
062812	12	4	28
062813	12,7	4	28
063214	14	4	33
063416	16	8,5	34

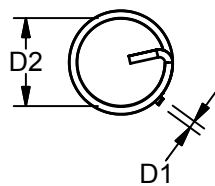

G RING

Polished stainless steel - AISI 316L

ART. NO.	D1	D2	PACK
070603	1,5	19	100
070604	2	23	100

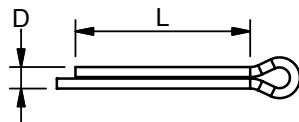

SPLIT PIN

Polished stainless steel - AISI 316L

ART. NO.	D	L	PACK
070613	3	25	100
0706131	3,2	20	100

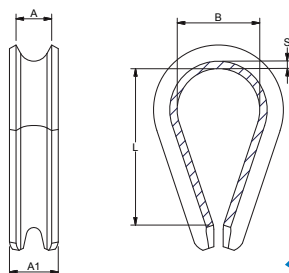

THIMBLE

Polished stainless steel - AISI 316L

ART. NO.	A	A1	B	L	S	KG/100	PACK
110007	8	11	19	33	1,5	1,4	100
110008	9	13,5	22	38	2	2,6	50

WIRE ROPE

On reels of 125, 250 and 500 meters. Other lengths available on request.

7x19

Stainless steel - AISI 316

ART. NO.	Ø	CONSTRUCTION	LENGTH
WR719081	8	7x19	125m
WR719082	8	7x19	250m
WR719083	8	7x19	500m



7x7

Stainless steel - AISI 316

ART. NO.	Ø	CONSTRUCTION	LENGTH
WR707081	8	7x7	125m
WR707082	8	7x7	250m
WR707083	8	7x7	500m



1x19

Stainless steel - AISI 316

ART. NO.	Ø	CONSTRUCTION	LENGTH
WR119081	8	1x19	125m
WR119082	8	1x19	250m
WR119083	8	1x19	500m

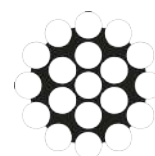

MACHINES AND TOOLS



WIRETEKNIK ROLLER SWAGING MACHINE

Machine including 8 mm die

ART. NO.	DESCRIPTION
WTA200	With hand pump
WTA200PUH1	With PUH1 power unit instead of hand pump
WTA200230V	Ready to use 230 V
WTA200400V	Ready to use 400 V
WTA20008	Extra roller die 8 mm

For fittings with OD 16 mm



HAND CRIMP TONG - DUBUIS 18V

ART. NO.	DESCRIPTION
DUBACC	Complete tool incl. battery and die
DUBBAT	Extra battery
DUB05D	Extra 8 mm die

For fittings with OD 13 mm

One-hand-operated arctool delivered in toolbox with a 18V 2200 mAh battery. Charges up to 1000 times. Each charge delivers power to press up to appx 100 times. For easy use and access on narrow places the head is turnable 180 degrees. The pressing force is 5,5 kN and a "click" will be heard when pressing is complete. The tool is CE certified.

WIRE CUTTER

Cuts up to Ø 12 mm cable

650 mm/2,8 kg

ART. NO.
ARCTOOL7





www.bluewave.dk

Blue Wave reserves the right to change specifications and descriptions contained in the Wave Line catalogue with no notification. Printing errors may occur. 2022/2023 - 1. edition.